



# 2N<sup>®</sup> Helios Force/Safety

Door Access Intercom



## Installation Manual

Version 1.0.0

[www.2n.cz](http://www.2n.cz)

The 2N TELEKOMUNIKACE a.s. is a Czech manufacturer and supplier of telecommunications equipment.



The product family developed by 2N TELEKOMUNIKACE a.s. includes GSM gateways, private branch exchanges (PBX), and door and lift communicators. 2N TELEKOMUNIKACE a.s. has been ranked among the Czech top companies for years and represented a symbol of stability and prosperity on the telecommunications market for almost two decades. At present, we export our products into over 120 countries worldwide and have exclusive distributors on all continents.



2N<sup>®</sup> is a registered trademark of 2N TELEKOMUNIKACE a.s. Any product and/or other names mentioned herein are registered trademarks and/or trademarks or brands protected by law.



2N TELEKOMUNIKACE a.s. administers the FAQ database to help you quickly find information and to answer your questions about 2N products and services. On [www.faq.2n.cz](http://www.faq.2n.cz) you can find information regarding products adjustment and instructions for optimum use and procedures „What to do if...“.



2N TELEKOMUNIKACE a.s. hereby declares that the 2N<sup>®</sup> Helios Force/Safety product complies with all basic requirements and other relevant provisions of the 1999/5/EC directive. For the full wording of the Declaration of Conformity see the CD-ROM (if enclosed) or our website at [www.2n.cz](http://www.2n.cz).



The 2N TELEKOMUNIKACE a.s. is the holder of the ISO 9001:2009 certificate. All development, production and distribution processes of the company are managed by this standard and guarantee a high quality, technical level and professional aspect of all our products.

# Content

<b>1. Product Overview</b>	<b>4</b>
1.1 Product Description	5
1.2 Upgrade	6
1.3 Components and Associated Products	7
1.4 Terms and Symbols	10
<b>2. Description and Installation</b>	<b>11</b>
2.1 Before You Start	12
2.2 Mechanical Installation	13
2.3 Electric Installation	21
2.4 Button Tags – Insertion and Replacement	25
<b>3. Programming and Use</b>	<b>26</b>
3.1 Programming	27
3.2 Full Parameter Chart	30
<b>4. Function and Use</b>	<b>36</b>
4.1 Function Description	37
4.2 Section for Advanced Users	46
4.3 Maintenance	51
<b>5. Technical Parameters</b>	<b>52</b>
<b>6. Supplementary Information</b>	<b>56</b>
6.1 Troubleshooting	57
6.2 Directives, Laws and Regulations	58
6.3 General Instructions and Cautions	59

---

# 1. Product Overview

---

In this section, we introduce the **2N® Helios Force** and **2N® Helios Safety** products, outline its application options and highlight the advantages following from its use.

Here is what you can find in this section:

- [1.1 Product Description](#)
- [1.2 Upgrade](#)
- [1.3 Components and Associated Products](#)
- [1.4 Terms and Symbols](#)

# 1.1 Product Description

## Basic Features

---

**2N® Helios Force/Safety** is a highly resistant and reliable door access intercom provided with a lot of useful above-standard functions. **2N® Helios Force/Safety** can work as a standard or emergency door access intercom for buildings, entrances to premises or garages, manufacturing halls, highways and so on.

**2N® Helios Force/Safety** is equipped with additional, 0,5 Watt audio amplifier. Without power supply, amplifier is bypassed and intercom is powered by telephone line.

**2N® Helios Force/Safety** can be provided with 1, 2 or 4 pre-programmed buttons. You can set up to six telephone numbers for each of the buttons to increase the accessibility of the called party.

**2N® Helios Force** can be equipped with a numerical keypad to be used as a code lock for lock switch activating or telephone/subscriber number dialling.

**2N® Helios Force/Safety** is equipped with an electric lock switch. You can control the switch using a numerical keypad or, during a call, using any telephone set. An additional switch module can be installed if necessary. A wide range of settings allow for a variety of applications.

**2N® Helios Force/Safety** is very easy to install. All you have to do is connect the system into your PBX and feed it from a 12 V power supply.

**2N® Helios Force/Safety** programming is easy, voice menu based, via telephone.

## Advantages of Use

---

- Uncompromising AntiVandal design
- Variable mounting options (brick/plasterboard flush mounting, surface mounting)
- Sensitive microphone and powerful loudspeaker
- Dial buttons including name tags and backlight (**2N® Helios Force**)
- Optional numerical keypad with backlight (**2N® Helios Force**)
- Integrated electronic lock switches with wide setting options
- Configuration via phone (voice menu based)
- Operates on any analogue telephone line
- Stable line power feeding
- High acoustic quality
- Special functions includes automatic dialling of multiple numbers, silent dialling, departure/arrival, day/night mode, second switch delay

## 1.2 Upgrade

The manufacturer reserves the right to modify the product in order to improve its qualities.

Version	Changes
1.0	-

## 1.3 Components and Associated Products

### Basic Units



			
<b>Part No. 9151201-E</b>	<b>Part No. 9151201K-E</b>	<b>Part No. 9151204-E</b>	<b>Part No. 9152101-E</b>
<b>2N® Helios Force</b>	<b>2N® Helios Force</b>	<b>2N® Helios Force</b>	<b>2N® Helios Safety</b>
1 button	1 button with keypad	4 buttons	1 button

**2N® Helios Force/Safety** is designed for outdoor applications and requires no additional roof.

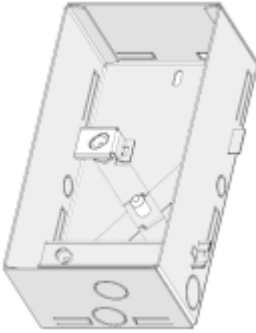
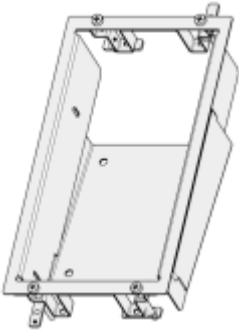

**2N® Helios Force** units can be flush or wall mounted without requiring any additional accessories. Use the appropriate mounting box (see below) for plasterboard and hollow brick flush mounting.

**2N® Helios Safety** units can be wall mounted (frame is not included, but can be ordered separately).

### Flush Mounting Box, Frame

 <p><b>Part No. 9151001</b> Brick flush mounting box</p>	 <p><b>Part No. 9151002</b> Plasterboard flush mounting box</p>	 <p><b>Part No. 9152000</b> Mounting frame orange Aluminum</p>
-----------------------------------------------------------------------------------------------------------------------------------------------	------------------------------------------------------------------------------------------------------------------------------------------------------	-------------------------------------------------------------------------------------------------------------------------------------------------------

## GSM and VOIP Connection Accessories

 <p><b>Part No. 501303E</b> <b>GSM gateway</b> EasyGate</p>	 <p><b>Part No. 91341711E</b> <b>Analogue/VoIP gateway</b></p>
-------------------------------------------------------------------------------------------------------------------------------------------------------	--------------------------------------------------------------------------------------------------------------------------------------------------------

## Electric Locks

 <p><b>Part No. 932070</b> BEFO 1211 12 V / 600 mA</p>	 <p><b>Part No. 932080</b> BEFO 1221 with momentary pin</p>	 <p><b>Part No. 932090</b> BEFO 1211MB with mechanical blocking</p>
-----------------------------------------------------------------------------------------------------------------------------------------------	----------------------------------------------------------------------------------------------------------------------------------------------------	--------------------------------------------------------------------------------------------------------------------------------------------------------------



## Other Accesories

---



**Part No. 91341481E**

12 V / 2 A adapter

Note: AC power supply is not applicable.

## 1.4 Terms and Symbols

The following symbols and pictograms are used in the manual:

 **Safety**

- **Always** abide by this information to prevent persons from injury.

 **Warning**

- **Always** abide by this information to prevent damage to the device.

 **Caution**

- **Important information** for system functionality.

 **Tip**

- **Useful information** for quick and efficient functionality.

 **Note**

- Routines or advice for efficient use of the device.

---

## 2. Description and Installation

---

In this section we describe the **2N<sup>®</sup> Helios Force/Safety** products and its installation.

Here is what you can find in this section:

- [2.1 Before You Start](#)
- [2.2 Mechanical Installation](#)
- [2.3 Electric Installation](#)
- [2.4 Button Tags – Insertion and Replacement](#)

## 2.1 Before You Start

### Product Completeness Check

---

Please check the contents of your **2N® Helios Force/Safety** delivery:

- 1× **2N® Helios Force/Safety** (selected model)
- 1× frame (**2N® Helios Force** only)
- 1× Torx 10 / Torx 20 double-ended wrench
- Bushings (enclosed):
  - 1× big two-hole sealed bushing with nut
  - 1× spare sealing for big bushing for a thick cable, one hole
  - 1× big blank with nut
  - 1× small bushing with nut
  - 1× bushing plug, big size
  - 2× bushing plugs, small size
- 1× **2N® Helios Force / Safety** Brief Manual
- 1× mounting template
- 1× CD
- 1× A5 transparent name plate foil
- 1× spare name tag
- 4× (5 × 90) mm screws
- 4× "intelligent" (8 × 50) mm dowels

## 2.2 Mechanical Installation

### Mounting Type Overview

Refer to the table below for a list of mounting types and necessary components.

#### Wall mounting

- (concrete and steel structures, entry barrier columns, etc.)

#### What You Need:

- Just your **2N® Helios Force/Safety** unit (the frame is not applied)

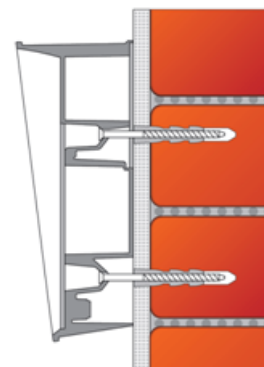

#### Flush mounting – classic bricks

#### What You Need:

- A precisely cut hole or, optionally, the brick flush mounting box, Part No. 9151001
- For **2N® Helios Safety**:
  - Mounting frame, Part No. 9152000

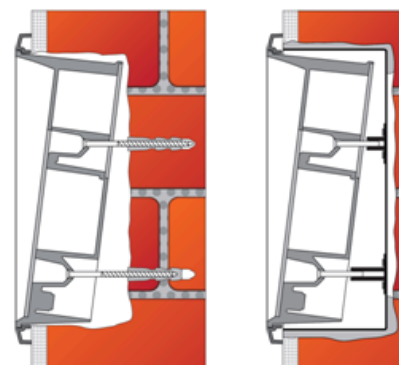

## Flush mounting – thermally insulated wall

### What You Need:

- Longer screws (depending on the thermal insulation thickness)
- For **2N® Helios Safety**:
  - Mounting frame, Part No. 9152000

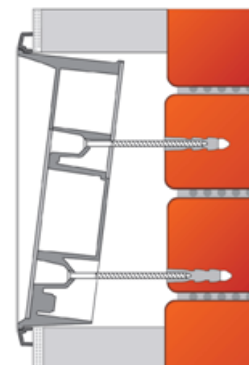

## Flush mounting – hollow bricks

### What You Need:

- Brick flush mounting box, Part No. 9151001
- For **2N® Helios Safety**:
  - Mounting frame, Part No. 9152000

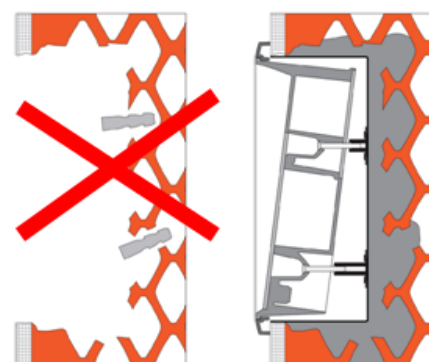

## Flush mounting – plasterboard wall

### What You Need:

- Plasterboard flush mounting box, Part No. 9151002
- For **2N® Helios Safety**:
  - Mounting frame, Part No. 9152000

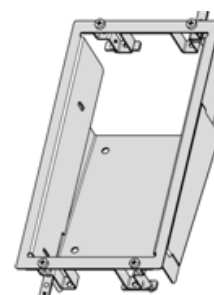

**⚠ Caution**

- The warranty does not apply to the product defects and failures arisen as a result of improper mounting (in contradiction herewith). The manufacturer is neither liable for damages caused by theft within an area that is accessible after the attached electric lock is switched. The product is not designed as a burglar protection device except when used in combination with a standard lock, which has the security function.
- When the proper mounting instructions are not met, water might get in and destroy the electronics. It is because the intercom circuits are under continuous voltage and water infiltration causes an electro-chemical reaction. The manufacturer's warranty shall be void for products damaged in this way!

## Common Mounting Principles

---

**✔ Tips**

- Select flush mounting where possible to make your product elegant looking, more vandal resistant and more secure.
- You can purchase the flush mounting box in advance and hire an installation professional to make the basic installation work. Moreover, the mounting box helps you align the intercom vertically (with a deviation of up to 2°).

**⚠ Caution**

- Make sure that the dowel holes have the required diameter. If the diameter is too large, the dowels may get loose. Use some suitable building adhesive to keep the dowels in place.
- Make sure that the hole depth is sufficient too! The dowel length is 50 mm and the screw length is 90 mm.
- Remember that dowels of poor quality may easily get loose and fall out of the wall!
- Stainless steel screws are used for the **2N® Helios Force/Safety** assembly. Other screws than stainless steel ones corrode soon and may aesthetically deteriorate the surrounding environment!
- Having removed the front panel, make sure that no dirt gets inside the product (especially onto the sealing surface and microphone sound guides).

**i Note**

- The microphone sound guides are normally loose after the front panel is removed! The screw is only used as a fall-out protection during installation.

## Wall Mounting

---

Wall (surface) mounting is used where flush mounting is inapplicable (in concrete and steel structures, entry barrier columns, etc.). The frame is not used.

**⚠ Caution**

- Wall mounting may be a problem where vandals may destroy the unit (in public garages, e.g.). Therefore, use steel fixing elements instead of the dowels and screws included in the delivery.
- Be sure to insert plugs into unused bushing holes to avoid water leakage during facade cleaning, for example. Never leave the holes open for even a short time (one day delay between mounting and cable connection, e.g.).

**⚠ Warning**

- Eliminate the risk of accident! Wall mounting is not suitable for narrow passages or places where people's attention may be distracted. The manufacturer shall not be liable for injuries incurred as a result of unsafe mounting!

1. Select the **2N<sup>®</sup> Helios Force/Safety** position with respect to the supply cables. Where the cables are installed inside a structure or wall, use the hole at the intercom bottom.
2. Drill holes of the depth of 70 mm for dowels in the wall as shown in the figure. Push or hammer the enclosed dowels into the drilled holes. Use some suitable building adhesive if the dowels are too loose. Use fixing elements of your own for steel structure surface mounting (metric screws + nuts, e.g.).
3. Remove the front panel from the intercom. The electronic parts of the two bottom buttons remain on the panel in the four-name plate version.
4. Select the holes for cable supply. Select and mount the bushings depending on the cables: 2-hole bushing or 1-hole bushing or both. Insert the blanks in the other holes.
5. Put the intercom on the wall/structure while introducing cables inside. Leave some of the cables inside the unit as a reserve. Insert the plugs in the unused bushings and tighten the bushing nuts carefully.
6. Do not complete mounting until you have finished electrical installation – refer to Mounting Completion. Where cables lead along the surface, use the bushings included in the delivery.

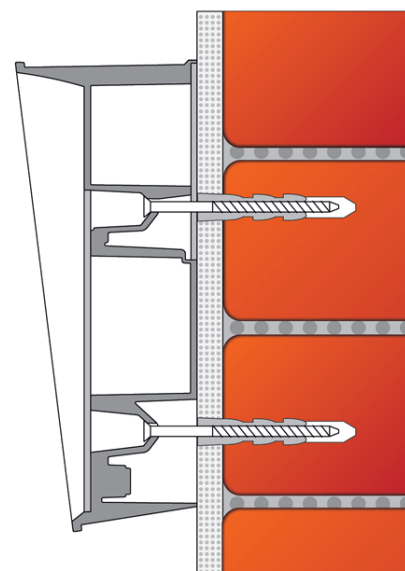



## Flush Mounting – Classic Bricks

If you use the brick flush mounting box, follow the instructions included in the box. If you do not use the mounting box, follow the instructions below:

1. Make a hole using the template. Suppose that all the required cables have been carried into the hole.
2. Unpack the frame, put the intercom inside and place the set onto the hole to make sure that the hole is deep enough and the uneven edge is perfectly covered with the frame.
3. Push or hammer the enclosed dowels into the drilled holes. Use some suitable building adhesive if the dowels are too loose.
4. Remove the front panel from the intercom. The electronic parts of the two bottom buttons remain on the panel in the four-name plate version.
5. Select the holes for cable supply. Insert the blanks into the other holes. Apply the cable bushings or a suitable sealant to prevent penetration of insects or water. You can also insert the small bushing in the intercom bottom hole.
6. Put the frame on the intercom.
7. Place the intercom into the hole while introducing the cables. Leave some of the cables inside the unit as a reserve and the rest under the intercom bottom.
8. Insert the enclosed screws in the lateral mounting holes making sure they have penetrated into the dowels. Tighten all the screws properly. Tip: The screw tightening sequence may affect the intercom position.
9. You can seal the frame – wall gap with a silicone or another sealant to avoid wall dampening as a result of water leakage. This additional sealing is unnecessary for the intercom function.
10. Do not complete mounting until you have finished electrical installation – refer to Mounting Completion

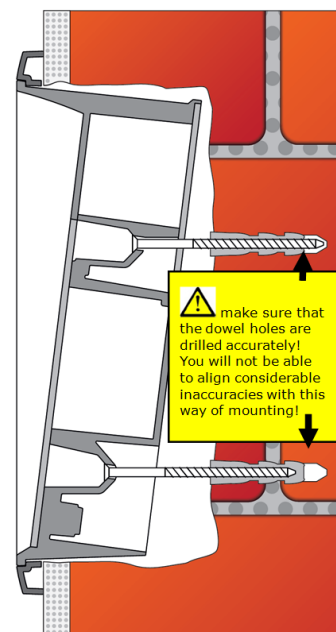

## Flush Mounting – Thermally Insulated Wall

Cut out the thermal insulation layer using the template (the same as for classic brick wall).

**⚠ Caution**

- The hole depth depends on the insulation layer thickness. If the insulation layer is rather thick, you may need longer screws! If there are hollow bricks under the insulation, make sure that your screws pass through the whole dowel (50 mm) and fix the dowel reliably.
- Make sure that the dowel holes have the required diameter. If the diameter is too large, the dowels may get loose. Use some suitable building adhesive to keep the dowels in place.
- Make sure that the hole depth is sufficient too! The dowel length is 50 mm and the screw length is 90 mm.

Suppose that all the required cables have been carried into the drilled hole. Now follow the instructions applicable for classic brick flush mounting. However, remember that thermally insulated walls show less strength than classic brick walls.

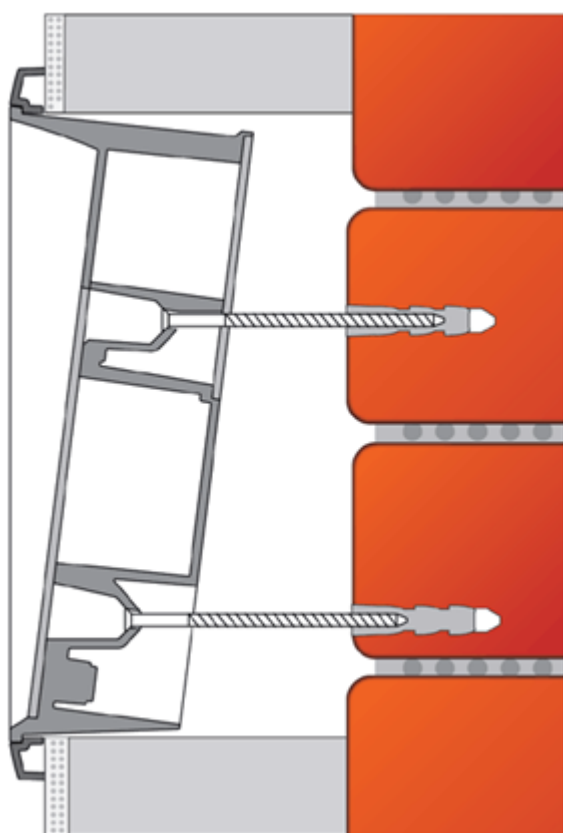

## Flush Mounting – Hollow Bricks

Suppose you intend to install your **2N<sup>®</sup> Helios Force/Safety** unit into a wall made of hollow bricks. Note that the external side of the bricks gets damaged by cutting and the dowels cannot practically be fixed into the thin internal part of the bricks. Therefore, use the brick flush mounting box and follow the instructions included therein.

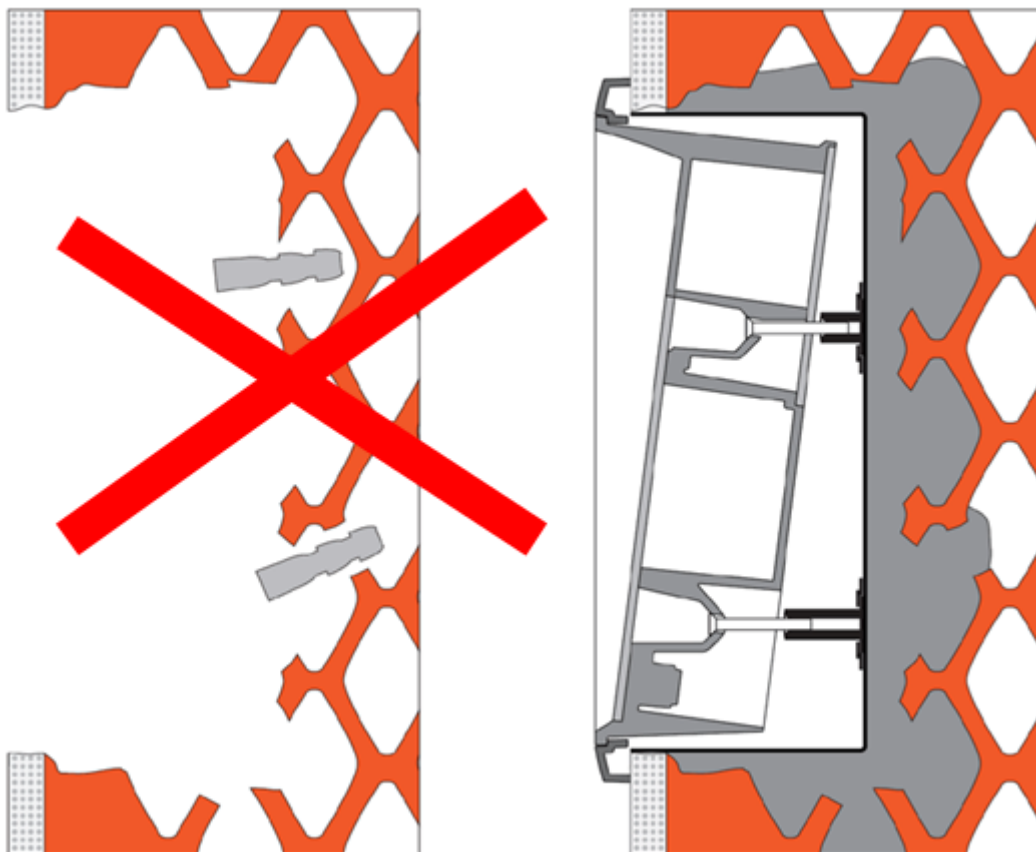

## Flush Mounting – Plasterboard

Use the plasterboard flush mounting box and follow the instructions included therein.

## Use of Cable Bushings

The cable bushings included in the **2N<sup>®</sup> Helios Force/Safety** delivery are designed for the following cables:

- **Big bushing:** for two cables of the diameter of 5–6 mm (UTP cable), or, upon insert replacement, for one thick cable/tube of the diameter of up to 14 mm.
- **Small bushing:** for one cable of the diameter of 5–8 mm.



- Even a LAN cable including the RJ-45 connector can go through the big bushing. See below for instructions.

## How to Pull a RJ-45 Terminated Cable through a Bushing

1. Unscrew the big bushing nut completely.
2. Remove the sealing including the cover from the bushing. Cut either of the components as shown in the figures.

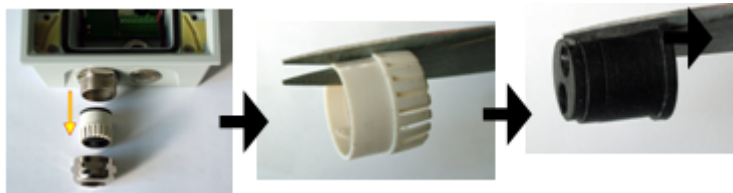

3. Put the bushing nut on the cable and insert the sealing.

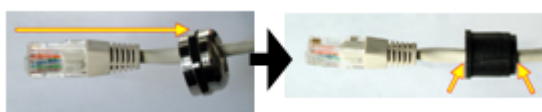

4. Replace the cover onto the sealing.



5. Pull the cable connector through the bushing body into the intercom and clip it into the motherboard connector.



6. Move the sealing including the cover along the cable as far as the bushing body, or add a plug if necessary.

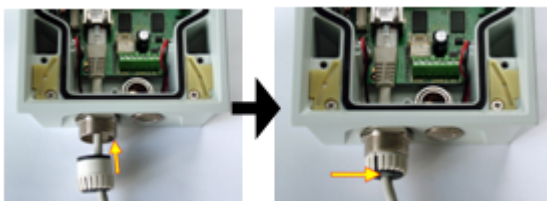

7. Replace and tighten the nut.



## 2.3 Electric Installation

This subsection describes how to connect **2N<sup>®</sup> Helios Force/Safety** to your PBX and how to connect supply voltage and the electric lock.

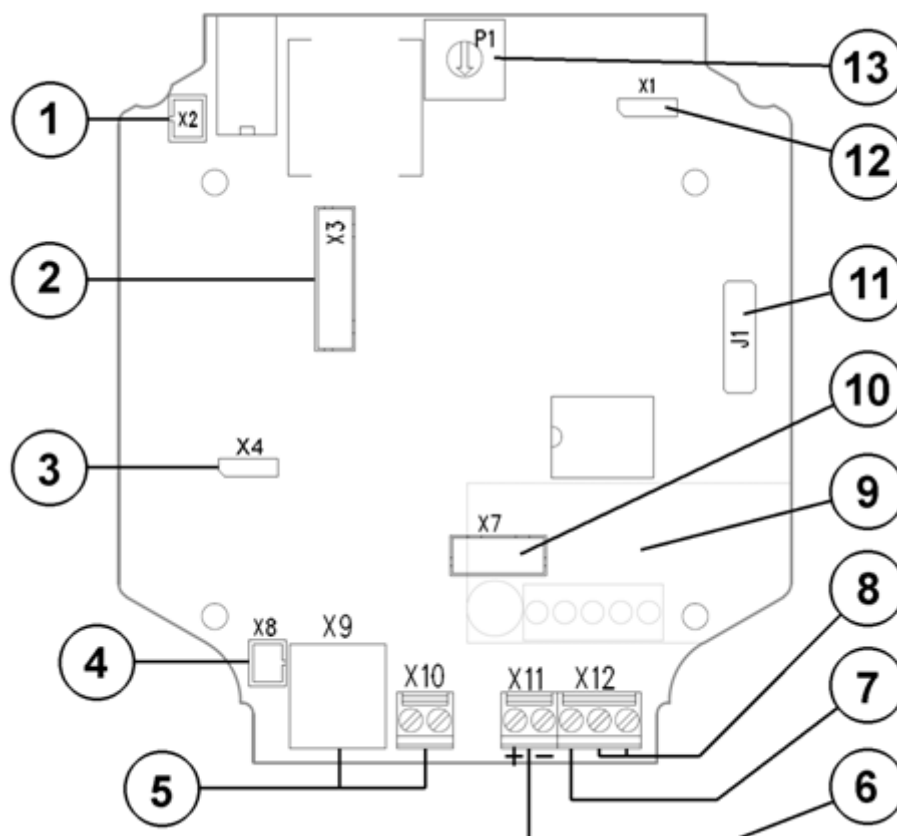

### PCB Connectors

Figure below shows the lay-out of connectors on the **2N<sup>®</sup> Helios Force/Safety** printed circuit board (PCB).



**Obrázek: 2N<sup>®</sup> Helios Force/Safety** Connectors, PCB Version 3

#### Description of Connectors

Number	Description
1	Loudspeaker connector
2	To pushbuttons
3	Microphone sensitivity attenuator: high (normal)  low
4	Microphone connector
5	Line connection: RJ-12 or screw terminals
6	DC power 12 V for power amplifier and for backlight
7	Protecting ground
8	Switch output
9	Additional switch
10	To keypad
11	Servicing connector
12	Power amplifier bypass: Amplifier ON  OFF (bypassed)
13	Power amplifier volume adjustment

## Compatibility

**2N® Helios Force/Safety** is designed for conventional, analogue telephone lines and works regardless of polarity and line parameters (Refer to the Technical Parameters) and uses tone (DTMF) dialling to be programmed. Normally, it is connected to a PBX line. However, it can also be connected to CO line or the GSM gateway, providing a wireless connectivity.

## Connection to Telephone Line

Connect **2N® Helios Force/Safety** simply using LINE terminals – RJ connector or terminal block. The advantage is that **2N® Helios Force/Safety** requires no power supply because all power is fed from the telephone line – except for the amplifier, button backlight and electric lock, if connected. Nevertheless, **2N® Helios Force/Safety** can work without these circuits too (amplifier is bypassed in this case).

**2N® Helios Force/Safety** sends an acoustic signal on having been connected to a line (or after having been disconnected from the line for a defined period of time).

## External Power Supply and Electric Lock Connection

**2N® Helios Force/Safety** require 12 V (**DC only!**) supply for:

1. Built-in audio amplifier – current draw of up to 100 mA,
2. Name tag and keypad backlight – current draw of up to 150 mA
3. Electric lock – current draw according to the lock type

The electric lock can be fed from the same source as the intercom or another supply.

**2N® Helios Force/Safety** contains a solid-state switch, which is able to switch both AC and DC regardless of polarity. Make sure that the current and voltage values do not exceed limits (refer to the Technical Data) and that the technical parameters of the lock and power supply are compatible.

**Warning**

- Never switch 230 or 120 V mains voltage directly!!!

**Caution**

- If the lock power supply fails and the telephone system carries on working, the intercom is unaware of the failure the switch will be password-activated and the activation is acoustically signalled, but the electric lock will not work because of the lack of power.
- Ground connection is mandatory. If used power supply output is grounded, you can connect GND terminal to it.

### Electric Lock Connection

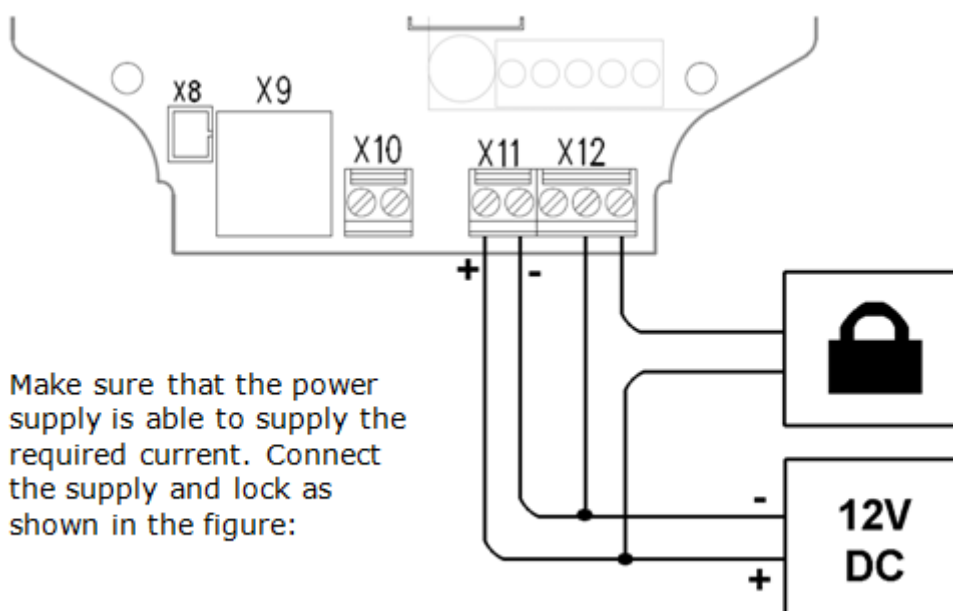

### Separate Backlight and Electric Lock Supply

Separate power supplies are necessary e.g. where the lock requires voltage higher than 12 V. In this case, an additional power supply (12V) must be used to illuminate the button backlight - see the figure below.

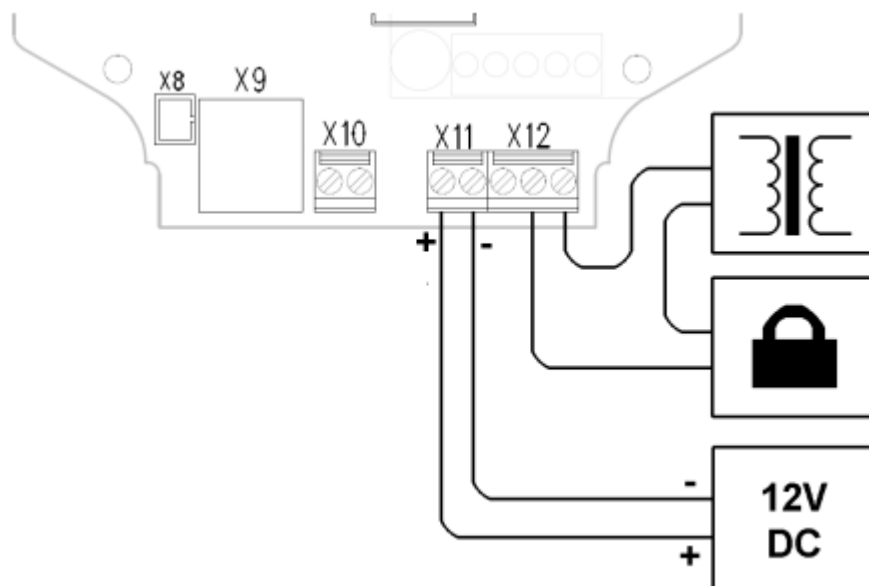

## Mounting Completion

1. Having connected all the wires, make sure that the bushings, if used, are tightened properly and the RJ-45 connector is inserted in the PCB connector (if used).
2. Replace the front cover carefully. Make sure that the wires inside the device leave enough space for the front cover assembly. Tighten the four screws thoroughly with the wrench enclosed (Torx 20) to make the panel fit tightly to the metal chassis.

### Caution

- An incorrect mounting may compromise the intercom water tightness. Water leakage may damage the electronic part of the system.
- Stainless steel screws are used for the **2N<sup>®</sup> Helios Force/Safety** assembly. Other screws than stainless steel ones corrode soon and may aesthetically deteriorate the surrounding environment!



## 2.4 Button Tags – Insertion and Replacement

### ⚠ Caution

- This feature is only for **2N® Helios Force**

### Tag Printing

Every name plate includes a piece of foil, which can be written over manually, using a waterproof permanent marker.

### ℹ Note

- Always use waterproof foil (enclosed or other) for the tags. Never use paper or ink jet printing to avoid damage due to water leakage!

### Tag Inserting/Replacing

**2N® Helios Uni** provides an intuitive, easy access to the name plates. The tags are easy to insert and replace even without a manual. You need not remove the front panel and thus are not exposed to the risk of loss of components while replacing the tags.

1. Loosen the name plate screw using the wrench enclosed, for example. You can open the name plate window like a door without losing the tightened screw.
2. Remove the used or blank name tag and insert a new tag.
3. Close the name plate window and tighten the screw appropriately.
4. Check the click effect of the buttons: if the button fails to click properly when pressed (when moved by approx. 0.5 mm), the tag is too thick or thin. Make sure that the button clicks when you press it on either end.

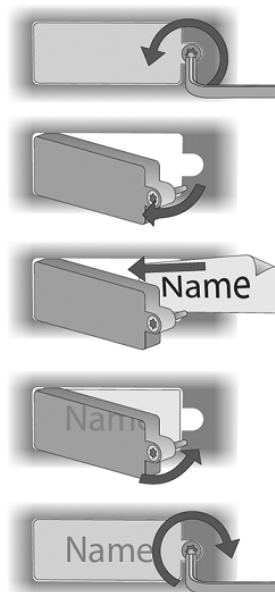

---

# 3. Programming and Use

---

In this section we describe the basic and extending functions of the **2N<sup>®</sup> Helios Force/Safety** product.

Here is what you can find in this section:

- [3.1 Programming](#)
- [3.2 Full Parameter Chart](#)

## 3.1 Programming

All the intercom parameters, including the keypad ones, are set remotely using any tone-dialling telephone set (or a mobile phone). First call the intercom and enter the programming mode. The access to this mode is service password protected.



A voice menu is available in the programming mode and so you need not use this manual to program standard parameters. The menu is stored in the intercom memory in the default language. Having entered the full parameter or memory number, you can hear how the parameter has been programmed, thus checking the programmed numbers for correctness.

All parameters are stored safely in the non-volatile EEPROM memory.

### Tip

- Write or print the values to be programmed to minimise the risk of error. Moreover, this gives you an idea of what you have programmed. Make sure that programming is not barred (JP1 jumper) – refer to the PCB Description subsection.

## Entering Programming Mode

You can enter the programming mode only during an incoming call (telephone – intercom call). The programming barring jumper must not be mounted. To get into the programming mode, enter the service password in the format  **password**  (do not forget to enter the asterisks before and behind the password!). The service password is 12345 by default and can be changed. If you enter the password correctly, the voice menu is launched. Now you can start programming.

## Programming Procedure

You can set parameters in any order and as many times as you wish. To change a parameter use the following command:

**Parameter number**  **parameter value** 

A three-digit **parameter number** is assigned to every parameter to be programmed and to every memory (refer to the Programming Chart). This number indicates to the intercom which parameter to change, and  is used as "Enter". When it is entered, the intercom repeats the parameter (or memory) number and reads the current contents (excluding passwords). Now you can enter new data – of variable meaning and length depending on the parameter selected (refer to the Full Parameter Chart).

Finally, press  again for confirmation. The intercom confirms the data saving. Repeat this procedure for each parameter.

## Switch Password Programming

Each switch can be controlled with up to 10 different passwords that are listed in the intercom memory. Passwords can be added to the list using function 811 and deleted with function 812 individually. The default status is a single password in the list, namely **00** for switch 1. This special password cannot be entered from the intercom keypad. To cancel them, you have to remove them from the list:

8 1 2 \* 0 0 \*

Function 997 deletes the entire password list including the password 00. Function 999 deletes the entire password list too but recovers the password 00 and the service password 12345.

## Password Selection Restrictions

Controlling the switch by phone, you can enter the password without any starting and terminating characters and the password length is not limited. The intercom has to verify after every character received whether the password is complete or not.

Therefore: **make sure that no password is identical with the beginning of another password.**

- Should you use such confusing passwords for switch control, you have to enter the longer password (by phone) with asterisks at the beginning and end.
- If the intercom refuses to store a password, it means that the switch password list is full, or the password has already been entered.
- The switch password may not be identical with any Arrival/Departure, Day/Night, or service password.
- For password selection tips see the Instructions for Keypad Use.

## Programming Error

- Any wrong value can be re-programmed by another command (immediately or any time later).
- If you make a typing error, cancel the entered value with \*. Then you can re-enter the whole number.
- If you enter an incorrect parameter number or parameter value, the intercom sends a refusal signal and you have to start with the parameter number again.
- If you do not press any button within a predefined timeout, the intercom sends a hang-up signal and hangs up. The timeout is 5 seconds; every \* character is followed by 30 seconds for you to think over your setting. The 5-second limit starts when the intercom has read all that relates to the current user position in the programming menu. The timeout can be prolonged – see the chart.

### Tip

- **To check programmed values:** enter parameter number and \*, listen the parameter value and press \* for return to the main menu.

## Deleting All Passwords, All Memories, Complete Initialisation





---

The following three functions facilitate your programming by clearing all previous settings:

- **997** – deletes the entire password list for switch including password 00.
- **998** – deletes memories of all buttons (01 - 02) plus Arrival/Departure and Day/Night passwords.
- **999** – clears the whole memory and resets the default values (see the chart).

### Protection against Unintentional Deletion

The above functions need no special "value" but must be protected against unintentional initiation. Therefore, enter the service password as the value. Warning: Full initialisation takes a few seconds, the intercom sends a continuous tone while memory clearing. Functions 997 and 998 take a little less time and are signalled by a continuous tone too.

The button memories can be deleted individually too – just enter a "blank" while programming. For example:      clears memory 1 of button 01.

## If You Forget the Service Password

---

If you forget the service password, contact the manufacturer. The manufacturer can change your service password to 12345 remotely without altering any other parameter.





- Keyboard letters facilitate password remembering. For example, it is easier to remember a 9-letter word (e.g. crocodile) than a 9-digit number (276263453).

## 3.2 Full Parameter Chart

All parameters are described in table below.



Parameter (function)	Parameter Name	Range	Default	Note
<b>011 to 016</b>	Button 01 memories	Up to 16 digits	blank	<p>X X X [X] TEL. NUMBER [X]</p> <p>└─ Memory number, <b>1 - 6</b></p> <p>└─ Button number, <b>01 - 04</b></p> <p><b>Note 1:</b> Button number 05–54 can be used to store pre-programmed numbers, accessible via keypad (enable parameter 922)</p>
...	...	...	...	
<b>011 to 046</b>	Button 04 memories	Up to 16 digits	blank	
Digits 0–9 can only be entered directly into the memories. Special characters are entered additionally using function XX7:				
017 ... 047	Enter special chars [X] [X] and pause			<p><b>Entering format:</b></p> <p>Button number, 01 - 04 — X X 7 [X] X X XX [X]</p> <p>1 = [X] 2 = [#] 3 = space</p> <p>Button memory number, 1 - 6</p> <p>Character position, 01 - 16</p> <p><i>Note: The digits behind this position are shifted automatically.</i></p> <p>Button numbers 05–54: see note 1 above.</p>
018 ... 048	Button 01 to 04 count of automatic dialling cycles	0-9	0 = off	<p>X X 8 [X] X [X]</p> <p>└─ Count of cycles, 0 - 9</p> <p>└─ Button number, 01 - 04</p> <p>Button numbers 05–54: see note 1 above.</p>
019 ... 049	Button 01 to 04 Arrival/Departure password	up to 16 digits	blank	<p>X X 9 [X] PASSWORD [X]</p> <p>└─ Up to 16 digits</p> <p>└─ Button number, 01 - 04</p> <p>Button numbers 05–54: see note 1 above.</p>
<b>559</b>	Day/Night password	up to 16 digits	blank	The same as for Arrival/Departure, identical for all buttons

<b>811</b>	Enter up to 10 switch passwords	up to 16 digits	00	Password 00 cannot be entered from the keypad! Up to 10 switch passwords Delete passwords using function 812
<b>812</b>	Delete valid switch passwords	Valid password		Deletes individual valid switch passwords.
<b>813</b>	Switch closing time	0-9 s	5 s	0 = switch disabled
<b>901</b>	Dialling type	0-1	0 = tone	1=pulse 40/60
<b>902</b>	Dialling timeout after pick-up	5-99	8 = 0,8 s	Range of 0,5-9,9 s
<b>903</b>	DTMF transmitting level	0-12	6	1 step = 1 dB
<b>904</b>	Automatic Multiple Number Dialling type	0-3	0 = disabled for all buttons	1 = loud with confirmation 2 = silent with confirmation 3 = SP without confirmation <sup>1)</sup> 4 = SP without confirmation <sup>1)</sup>
<b>906</b>	Ticking into call	0-12	0 = off	The called party recognises better that the incoming call is from the intercom.
<b>911</b>	Count of rings before incoming call answering	1-99	2 	Warning!!! No connection is established if a higher value is entered than as allowed in the PBX ringing timeout!!!
<b>912</b>	Max. call duration	1-99	12 = 120s	Range of 10-990 s
<b>913</b>	Log-in timeout	1-99	3	3 = 30 seconds
<b>915</b>	Hang-up time between calls	5-99	15 = 1,5 s	
<b>921</b>	Code lock mode	0-1	1 = enabled	0 = disabled 1 = enabled For details on these functions see the Keypad Description.
<b>922</b>	Buttons replaced by keypad	0-1	0 = disabled	
<b>923</b>	Telephone mode	0-1	0 = disabled	
<b>924</b>	Tone dialling during call	0-1	0 = disabled	
<b>931</b>	Microphone power-up level	0-3	2	0 = Maximum microphone sensitivity
<b>932</b>	Automatic response speed	0-3	2	3 = Maximum response speed
<b>933</b>	Reception volume	0-15	7	15 = Maximum reception volume

<b>934</b>	Transmission volume	0-15	7	15 = Maximum transmission volume
<b>935</b>	Message volume	0-15	7	15 = Maximum message volume
<b>936</b>	Beeping volume	0-12	12	12 = Maximum tone volume
<b>937</b>	DTMF hearing (side tone) volume	0-3	3	3 = Maximum DTMF volume
<b>938</b>	Loudspeaker volume	0-15	7	15 = Maximum loudspeaker volume
<b>941</b>	Minimum continuous tone time	10-99	20 = 2 s	If the tone is longer, the intercom hangs up.
<b>942</b>	Minimum busy tone or pause duration	0-255	8 = 0,08 s	These parameters control the busy tone detection. They are used for call termination and automatic dialling.
<b>943</b>	Maximum busy tone or pause duration	0-255	70 = 0,7 s	
<b>944</b>	Maximum tone-pause difference	0-255	10 = 0,1 s	
<b>945</b>	Minimum count of busy tone periods	2×9	4	
<b>946</b>	Dual tone detection setting	0-10	4 = 440 Hz	All continuous, busy and ringing tones are detected. Dual tones are detected if one of their components is between 400 and 500 Hz. If both components are in this range, set a lower detection value. Set 0 for 400 Hz and 10 for 500 Hz. This setting does not affect the single tone detection, which always works between 300 and 550 Hz.
<b>951</b>	Minimum ringing tone time	1-200	50 = 0,5 s <sup>2</sup> )	The longest ringing period pause must be in the interval between parameters 952 and 953.   Warning! As these parameters also detect incoming calls, an incorrect setting may result in the intercom not answering the call!
<b>952</b>	Minimum long pause time	5-100	10 = 1 s	
<b>953</b>	Maximum long pause time	10-100	60 = 6 s	



<b>954</b>	Count of ringing periods	1-99	10	If the preset count of periods is exceeded, the call is terminated.
	If the preset count of periods is exceeded and automatic dialling is enabled, another attempt follows. In the event of Automatic Dialling <u>wit hout Confirmation</u> , the ringing tone is recognised and ends before the preset count of periods is exhausted; the call is regarded as successful.			
<b>961</b>	Maximum timeout for pressing the next digit	1-9	5 s	During password entering, etc.
<b>963</b>	Possibility to hang up by pressing the same button	0 = no 1 = yes	1	
<b>964</b>	Possibility to dial the next number by pressing 2nd button	0 = no 1 = yes	1	
<b>971</b>	Count of message repetitions	0-9	3	There is a 3-second pause between every two messages.
<b>974</b>	Intercom identification number	16 digits	-	The number enables intercom identification.
<b>975</b>	Message options for automatic multiple number dialling	2 digits	55	<p><b>1<sup>st</sup> digit</b> = type of message repeated after dialling.</p> <p><b>2<sup>nd</sup> digit</b> = type of message after confirmation.</p> <p>The following digits are used:  2 = identification (974) - loud speaking  4 = identification (974) - DTMF  5 = message as defined in par. 977  (after confirmation by par. 976)  7 = confirming tone (after confirmation only)</p>

<b>976</b>	language selection for a message	0-8	1	<p>0 = </p> <p>1 = English</p> <p>2-3 = </p> <p>4 = German</p> <p>5-7 = </p> <p>8 = Portuguese 9 = Dutch 10 ... 99 = silence</p> <p>Note:</p> <p>See <b>Survey of messages</b> in Subs. 4.2</p> <p><b>Caution!</b> Czech version has language order: 1 = Czech, 2 = English</p>
<b>977</b>	language selection for "wait, please" message	0-8	1	
<b>991</b>	Service password		12345	12345 by default
<b>995</b>	Software version identification	-		This function reads out the current software version. Format: year-month-day. Writing disable.
<b>997</b>	Deletion of all switch passwords	Service password	12345	Deletes password 00 too.
<b>998</b>	Clearing of all memories		12345	Clears memories 01 to 55.
<b>999</b>	Full initialisation		12345	Warning! Changes the service password too (setting the default value of 12345).

### Notes

- Terminology: For the purpose hereof, **parameter** means a **value** that is stored in the intercom memory and can be re-programmed. **Function** is a means of execution of another service such as initialisation, software version identification and so on.
- <sup>1)</sup> Types 3 and 4 of Automatic Dialling without Confirmation differ from each other in how they process very short calls (a few seconds). Dialling type 4 regards a call as successful in all cases, type 3 only if the door was opened.

## Explanation of Some Parameters

### Explanation of Parameters 951, 952, 953

#### Ringling tone (example)

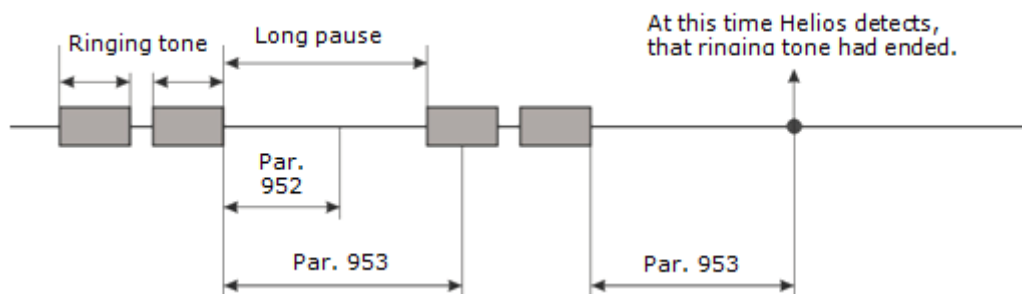

### Explanation of Parameters 942, 943, 944

#### Busy tone

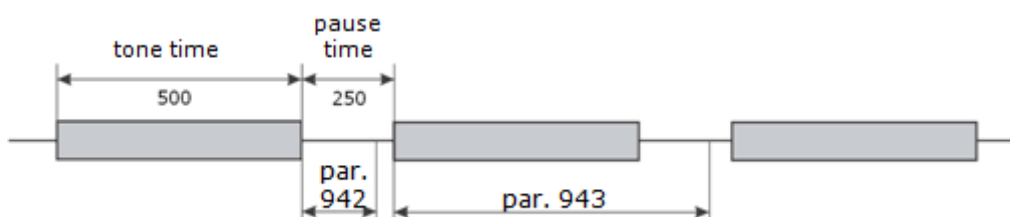

#### **Example:**

The busy tone in the figure above is considerably longer than the pause time. Therefore, set parameter **942** according to the pause, to 200 ms, e.g., and parameter **943** according to the tone, to 600 ms, for example. In this case, however, the default values can be maintained for both the parameters. Since the tone – pause difference is  $500 - 250 = 250$  ms, **set parameter 944** to 300 ms, for example.

#### **Note**

- Increase parameter 944 also when the intercom is placed in a hall or corridor with a large decay time.

---

# 4. Function and Use

---

This section describes the basic and extending functions of the product.

Here is what you can find in the section:

- [4.1 Function Description](#)
- [4.2 Section for Advanced Users](#)
- [4.3 Maintenance](#)

## 4.1 Function Description

### From External User's View (Visitor)

Like normal doorbells, intercom buttons are provided with labels. The visitor finds the appropriate button (e.g. Mr. Smith) and presses it. This activates the intercom, which then dials the number pre-programmed for that button. The visitor can then hear the ringing tone from the loudspeaker and the required (Mr. Smith's in this case) telephone is ringing. If the intercom is connected to a telephone system, you can tag the port the intercom is connected to in order to see on the ringing phone that it is the intercom that is calling. When the called party answers the call, the visitor and the called person can speak to each other and, if an electric lock is connected to the intercom, the called person can open the door by entering the correct password on the telephone keypad to activate the door or barrier. When the caller hangs up, the intercom detects the PBX or analogue line tone and hangs up too. The intercom also hangs up when it "hears" the busy tone or if the call takes more time than as pre-programmed to connect. You can pre-program the amount of time that you have to speak into the microphone, but when you reach the programmed time, the unit will send a warning tone 10 seconds before hanging up so that the called party can extend the call if required.

#### Notes

- If the visitor presses another button during the call, the intercom hangs up for a few seconds before dialling the new number.
- If a button is pressed that has no number stored within it, the intercom picks up the line, sends a refusal tone (refer to the Signals Overview) and hangs up.
- If the visitor presses the same button during the call, the intercom may hang up (can be programmed to stop this feature if required).
- The above mentioned rules are only applied if the Automatic Multiple Number Dialling mode is OFF. For this special mode refer to the Automatic Multiple Number Dialling section.

### Function Description – Numerical Keypad Models

**2N® Helios Force** model **9151201K-E** is equipped with a numerical keypad. The keypad provides a number of functions:

- traditional code lock
- features as if a normal telephone set
- DTMF transmission during an outgoing call
- substitution of up to 54 buttons

The keypad features a smart metal design and very favourable price to performance ratio. For the description of the functions from the user's view see below.

## From Internal User's View (Survey of Functions)

---

### Calling to 2N<sup>®</sup> Helios Force/Safety

You call the appropriate extension and the intercom makes the call and gives a confirmation tone after two rings (or as pre-programmed). Now you can speak and control the switch, program the intercom (see later), and listen to what is going on outside and speak to the calling party if desired.

### Door opening

The intercom contains a switch to which an electric lock can be connected (not included in this pack). This switch can be telephone keypad controlled using a (digital) password in two ways as shown in the default password 00 example below:

00 or \*00\*

The switch activation time can be programmed once the switch is enabled this will also automatically terminate the call in the next 30 seconds.

#### Note

- If the Automatic Multiple Number Dialling with Confirmation or the Silent Automatic Multiple Number Dialling with Confirmation mode is selected and the password starts with digits 1 to 5, an asterisk must always be used.
- **You Must** enter every digit in the password within five seconds (or as pre-programmed) to avoid the intercom hanging up.

### Switch 2 activation (light, e.g.)

The second switch (if an additional switch is installed) can be controlled in the same way, default password is 11.

### Switch 2 synchronisation

Switch 2 can also be used to delay the opening of another door. Once the switch 2 delay timeout is programmed, the second switch is synchronised automatically with the first one, the delay being 1 – 25 seconds.

### Switch activation signalling (for both switches)

After the correct password is entered, the switch is activated and you can hear the confirmation signal on your telephone. You can now speak (e.g. say: "The door is open") or listen (to the door-opening sound, etc.) until the switch is deactivated. Upon deactivation, you can hear the storing signal (see the Signals Overview).

## Call extension

The intercom beeps 10 seconds before the call end. To extend the call by 30 seconds press  on your telephone (DTMF). You can use this function repeatedly. The visitor, however, cannot use this function!

## Programming





The access to this mode is password-protected. For details refer to the Programming section. The voice menu helps you considerably with programming the intercom. Having entered the programming mode, you can also alter any parameter and memory settings.





### Caution

- The above mentioned functions (except for calls to the intercom) require a **tone-dialling** telephone set.

## Signals Overview

Signal	Name	Meaning
	Confirmation	sent immediately after line seizure for incoming calls (can be heard by the calling party); signals switch activation (by DTMF) – can be heard by the person "at the other end" who activated the switch
	Refusal	signals that a non-programmed button has been pressed; signals that an incorrect password has been entered on the keypad; can be heard from the loudspeaker after line connection (first connection signalling); signals an incoming call if intercom has not been programmed; When a disabled function has been entered from the keypad.
	Storing	Signals switch deactivation (if activated by DTMF).
	Hang-up	Sent to notify that the call is terminated (in all cases).
Long continuous tone		signals that the unit is going through full initialisation or dialling memory or password clearing; Heard from the loudspeaker while the switch is activated by keypad.
"Attention, your call is being terminated"		signals that the preset maximum call time will elapse within 10 seconds during outgoing and incoming calls
"Wait, please"		Optional message during call establishing
"Communicator number .....is calling"		Optional message for communicator identification
Voice menu		In the programming mode.

## Call Termination Options – Summary

1. The busy or continuous tone \*) after the call end.
2. The ringing tone \*) after a predefined count of rings.
3. The subscriber 'at the other end' pressed  .
4. The preset maximum call duration has elapsed.
5. 30 seconds after the switch use has elapsed.
6. An intercom button was pressed during the call.
7. The  keypad button was pressed during the call (can be disabled).

\*) The intercom is able to detect a permanent tone, busy tone and ringing tone even if the tone has two frequency components as in the UK, the U.S.A. (the so-called BTT tone) and in Canada. This new function does not require setting of any parameter. One of the tone components must be of 440 Hz.



## Code Lock

The electronic lock connected to intercom can not only be activated by the phone but also directly from the door using the keypad. In this mode, the keypad behaves like a standard code lock with the following features:





- Both switches can be controlled (if 2 connected)
- Password length – 1 to 16 digits;
- Up to 10 passwords per switch;
- Switch activation time – 1 to 9 seconds;
- Acoustic switch activation signalling – continuous tone.

The code lock uses the same passwords as the ones that have been defined for the telephone based switch control. Remember that the default passwords (**00** for switch 1 and **11** for switch 2) cannot be entered from the numerical keypad because they are notoriously known.

### Control

Enter the correct password and . If the password is valid, a long tone is transmitted for a predefined time (5seconds by default). The corresponding switch is activated during this time. If the password is invalid, intercom sends a refusal signal.

## Traditional Telephone

Any number can be "dialed" in this mode. To dial, press , and to hang up use . These keys are typically provided with pictograms  and . PSTN calls can be barred for a line in the PBX. The dialling type (tone, pulse) is selected in the programming mode. With pulse dialling, the  character initiates (upon off-hook) transition to tone dialling – like on any other telephone.

#### Note

- If this function is enabled, you can press  to hang up an outgoing call initiated by pressing a separate button.

## DTMF Transmission during Outgoing Call

This function enables the unit to transmit DTMF tones when the connection with one of the pre-programmed numbers has been established. It is used in combination with automatic information systems, voice mailboxes, etc., which ask the calling party to select a service using tone dialling. This function, however, does not allow you to call destinations other than the pre-programmed ones.

## Buttons Substitution

---













This function is an analogy to memories in comfortable telephone sets. After two digits ranging between 01 and 54 (0 may not be omitted) are pressed, the call to the pre-programmed number is made. You can use intercom as if it had up to 54 separate buttons, which saves buying the extender units and space on the installations wall. The ideal solution is to use a few standard buttons for the most important speed dialling options e.g. Warden, Reception and then provide a list of pre-programmed options via the optional info panel that can be purchased.

### Admissible Keypad Function Combinations

All of the above mentioned 4 functions can be combined freely – each of them can be enabled or disabled separately as desired.

## Keypad Operation Instructions - Summary

---

- **Door opening – code lock**
  - Enter any valid password for switch 1 and  .
  - **Warning!** Password 00 may not be used!
- **Switch 2 activation**
  - Enter any valid password for switch 2 and  .
  - **Warning!** Password 11 may not be used!
- **Traditional button telephone**
  -  gets intercom ready to dial a number.
  - ... Dials a number.
  -  Transmits into tone dialling during pulse dialling.
  -  Transmits a character in tone dialling.  Hangs up anytime during a call.
- **DTMF transmission during outgoing call** (of a single button, not in the telephone mode!)
  - ... tone-dials a number.
  -  The character is sent normally.
  -  The character is sent normally.
- **Buttons substitution:**
  - 01...54 – the number that complies with the selected button (memory) is dialled after a timeout.
  -  – If an asterisk is pressed after number 01...54, the number is dialled immediately unless it is identical with the set password.





## Frequently Asked Questions About Keypad Function

- **Can any of the switches be activated permanently?** Yes, the additional switch can be activated by one password and deactivated by another.
- **Is it possible to arrange for the switch to be activated during the whole call?** Yes, additional switch can do it.
- **Is it possible to use a single command to activate one switch first and the other later?** Yes, it is possible to use parameter 824, Switch 2 delay.
- **Can both the switches be activated at the same time?** While one switch is activated, the other can be activated by another password. You can also use parameter 824, Switch 2 delay, defining the shortest delay time possible (1second) and a sufficiently long switch activation time.
- **Can I use the code lock while another person is speaking through intercom?** Yes, but this is not advisable as you should be aware that the password is private and could contravene security.
- **What happens when I press a number with no pre-programmed memory while the button replacing function is enabled?** The same as if you pressed a button that is not pre-programmed: intercom seizes the line, beeps refusal (refer to Signalling) and hangs up immediately.
- **What happens if a password is identical with the memory number while the code lock and button substituting functions are enabled?** The code lock function has the highest priority. If, for example, the password is 33 and you press **33\***, the switch is activated instantaneously. If you press **33** without an asterisk, the line is seized after a preset delay and the number from memory 33 is dialled.

### Tips

- Keyboard letters facilitate password remembering. For example, it is easier to remember a 9-letter word (e.g. crocodile) than a 9-digit number (276263453).
- It is not recommended to use such passwords as 3333. This leads to a considerable wear and tear of one button and an unauthorised person may guess your password easily. It is ideal to employ all keys evenly, using several codes for different persons or groups.

## Intercom Statuses and Available Operations

Operation		Hang-up	Outgoing call	Incoming call	Programming	Telephone mode
Button pressing – new call			×	–	–	
Call extension – DTMF 		–			–	
Call termination – DTMF 		–				
Hang-up upon continuous, busy or ringing tone		–				
Switch activation – DTMF password		–	×	×	–	×
Programming start		–	–		–	–
Keypad	Switch activation – code lock	×	× 1)	–	–	–
	DTMF into outgoing call	–	×	–	–	2)
	Button replacing (speed dial from memory)	×	×1)	–	–	–
	Off-hook by key  (into telephone mode)	×	–	–	–	–
	Hang-up by key 	–	1)	–	–	
	Hang-up by key 	–	1)	–	–	–

### Explanatory notes:

- ... Yes, always
- × ... Yes if this function is programmed
- 1) This holds if DTMF is disabled during outgoing calls (the corresponding tone is transmitted in that case).
- 2) If pulse dialling is selected, it is possible to switch into tone dialling by

pressing  (but not vice versa!).

## 4.2 Section for Advanced Users

### Automatic Multiple Number Dialling

When you press an intercom button, you may find out that the called line is busy or the called party is absent. The intercom is able to identify these situations and solve them by Automatic Multiple Number Dialling if one of three automatic dialling modes is enabled. Up to 6 numbers can be stored for each button.

The three automatic modes (see below) recognise the continuous, busy and ringing tones. In all of these modes, automatic dialling can be disabled or the required count of cycles can be preset (1 to 9; if none of the stored numbers is answered, the whole cycle is repeated starting with the first number again) for each button separately.

You can program Automatic Multiple Number Dialling for selected buttons only, retaining the others in the default mode, the selection of one of three automatic dialling modes is common.

#### Automatic Multiple Number Dialling without Confirmation

This mode can be used in common cases to enable the visitor to get through even if the called line is busy or the called subscriber is absent. Hence, the second memory of the button may include the secretary's number, the third memory the porter's lodge number, etc.

This mode recognises the ringing tone and if the tone ends before the predefined count of rings, the intercom regards this as a successful connection, this solution is not fully reliable because detection may be hindered by noise, etc. No message is played back in this mode.

#### Evaluation of Situations in Audible Automatic Dialling without Confirmation

Situation	Intercom Action
Busy tone	Hangs up in approximately 2 seconds and dials the next number.
Call or silence without previous ringing tone	Waits for the preset timeout (log-in time), then hangs up and dials the next number.
Continuous tone (at the PBX, e.g.)	Hangs up in approximately 2 seconds and dials the next number.
Ringing tone, which is terminated before 10 rings are made (the count of rings is variable)	Regarded as a successful call, continues for the maximum timeout (maximum call duration). For details refer to the text under the table.
Ringing tone, 10 rings are made (the count of rings is variable)	Hangs up and dials the next number.
1 to 9, 0	These digits are interpreted as password beginning.
*	Call extension or password beginning.
#	Hang-up command.

If the ringing tone stops before the predefined count of rings is achieved and the call is thus very short (e.g. 2 seconds), it is not clear whether the call should be regarded as successful. Therefore, a new type of automatic dialling has been added – type 4.

#### The difference is as follows:

- Type 3 regards such a call as successful only if the door is opened.
- Type 4 regards all such calls as successful.

### Automatic Multiple Number Dialling with Confirmation

This mode is used where maximum connection reliability is required – for emergency calls. The called line (the supervisory control centre, e.g.) must be operated by a well-trained person to confirm connection. The DTMF is used as the most reliable criteria for successful connection. The called line must press **1** on its telephone. If the called number is busy or remains unanswered until the preset timeout or in other cases (see the table), the intercom dials the next number in the sequence.

#### Evaluation of Situations in Audible Automatic Dialling with Confirmation

Situation	Intercom Action
Busy tone	Hangs up in approximately 2 seconds and dials the next number.
Call or silence	Waits for the preset timeout (log-in time), then hangs up and dials the next number.
Ringing tone	Waits for the preset count of rings, then hangs up and dials the next number.
Continuous tone (at the PBX, e.g.)	Hangs up in approximately 2 seconds and dials the next number.
DTMF char <b>5</b> or <b>#</b>	Immediately hangs up and dials the next number.
DTMF char <b>1</b>	Confirms reception (2 beeps) and the call continue for the preset time at most (maximum call duration).
<b>1 2 3 4 5</b>	These digits are interpreted as control characters – refer to the DTMF Control subsection.

#### **i** Note

- It is sometimes difficult to recognise the above-described situations reliably due to a poor quality of the PSTN connection. Excessive noise in the surroundings may also have a negative impact. However, this may only decelerate automatic dialling (the busy tone may not be recognised, e.g.). Even if the intercom cannot identify the DTMF, the connection is established (yet for a shorter time).

## Silent Automatic Multiple Number Dialling

This mode fully conceals the fact that a telephone call is made. When a button is pressed, the loudspeaker is off and no PBX or dialling tone can be heard. The loudspeaker is switched on when the called subscriber confirms connection (by pressing  on its telephone). Thus, a potential thief cannot establish whether the called person is in the building or not.











Otherwise, the function is the same as with Automatic Multiple Number Dialling with Confirmation.

## Intercom Identification

There are situations in which the calling person does not want to or cannot speak for security reasons in the automatic dialling mode. In these cases, the intercom can play back a message stored in its memory. The test series includes the "Wait please, connection is being established" message. Later, more messages will be available to the user.

## DTMF Control

If Automatic Multiple Number Dialling with Confirmation or Silent Automatic Multiple Number Dialling is enabled, the intercom can be controlled as shown in the table below. For convenience, commands 1 to 5 are arranged as they are usually used.

DTMF Character	FUNCTION
	<b>Confirmation</b> indicating to the intercom that the call was successful. The intercom sends its confirmation signal, the call goes on until the end of timeout and any of the following commands can be used.
	Message <b>muting</b> (during playback). <b>WARNING!</b> You may not speak while the intercom is playing back the message!!!
	Message <b>re-plays</b> (once).
 or 	<b>Call extension:</b> a call is extended by 30 seconds by this command. Can be used repeatedly.
 or 	Call <b>termination</b> .
 to  	These digits are interpreted as a password beginning - for switch control.

### Notes

- These commands do not work in the Automatic Multiple Number Dialling mode without Confirmation!
- The above-mentioned commands **may not be accepted** due to poor connection if sent during a message. To avoid this, press the button during the time of silence (between messages).



## Survey of Messages

The table below includes a survey of language versions for standard announcements. English is selected by default. To select another language, use parameters 976 and 977.

Value of parameter 976	Language selection – English version	End of call message	Outgoing call message	
			ID message. Parameter 975 must contain digit 2, 3 or 5	Confirmation message. Parameter 975 last digit = 5
0	Tone signal	♪♪	off	off
1 (default value)	English	Attention, your call is being terminated.	Communicator number..... is calling .	Connection confirmed.
2	German	Achtung, das Gespräch wird beendet.	Es ruft das Notruftelefon Nummer.....an.	♪♪
3	Portuguese	.....	.....	♪♪
4	Dutch	.....	.....	♪♪

Value of parameter 977	Language selection – English version	Outgoing call message	Note
0	Tone signal	off	<ul style="list-style-type: none"> <li>To play this message, parameter 975 must start with digit 5.</li> <li>Parameter 977 has a range 0 – 99. On customer's request, additional messages can be added; e.g. other languages or more alternative messages in one and the same language.</li> </ul>
1 *)	English	Wait please.	
2	German	Warten Sie bitte.	
3	Portuguese	.....	
4	Dutch	.....	

## Arrival/Departure, Day/Night Modes

2N® Helios Force / Safety can identify easily where to 'route' (switch) a call after a button is pressed. All you have to do is call the intercom and enter the following:

- I'm leaving:  password  1
- I'm back:  password  0





All buttons can be switched all at once by a common **Day/Night password** or individually by separate **Departure/Arrival passwords**.

## How does switching work?

- Every button has memories for 6 numbers (intended primarily for Automatic Multiple Number Dialling).
- If the Automatic Multiple Number Dialling mode is **OFF**, memory **1** is used for the Day mode and memory **3** for the Night mode. This is a simple two-number switching.
- If the Automatic Multiple Number Dialling mode is **ON**, memories **1, 2, 3, 4, 5, 6** are used for the Day mode and memories **3, 4, 5, 6** are used for the Night mode in the above-mentioned order. This accelerates the process; numbers that would not be answered are skipped over.
- If the Night mode is on and memories 3 to 6 are empty, memories 1 and 2 are used.
- If the **Night** mode is on, memories 1 and 2 are omitted for **all** buttons and this cannot be disabled individually using the Arrival function.
- In the Day mode, the buttons assigned to persons who used the Departure function (are on a leave) shall remain in the Night mode until the same persons use the Arrival function (after the leave, e.g.).



### Example 1 – administration building, automatic dialling is off:

Button 01: labelled Mr. Smith, memory 1 = Mr. Smith's line, memory 3 – secretary's line, password for button 01 is 777.

1. Mr. Smith is leaving for holiday. He calls the intercom and enters:  777   
1 
2. A visitor comes, presses Mr. Smith's button – the intercom calls the secretary.
3. Mr. Smith comes back. He calls the intercom and enters:  777  0.

### Example 2 – family house, Silent Automatic Multiple Number Dialling:

Button 01: labelled The Johnsons, memory 1 = living room, 2 = workshop, 3 = Mr. Johnson's mobile telephone, 4 = Mrs. Johnson's mobile telephone. Arrival/Departure password for button 01 is 333.

1. The family is leaving for holiday. They call the intercom and enter:  333  1  
 .
2. A visitor presses the Johnsons' button – the intercom calls Mr. Johnson's mobile phone and, if unsuccessful, Mrs. Johnson's mobile phone.

## 4.3 Maintenance

### Cleaning

---

If used frequently, the intercom gets dirty. To clean it, use a piece of soft cloth moistened with clean water. We recommend you to obey the following principles while cleaning:

- Never use aggressive detergents (such as abrasives or strong disinfectants).
- Alcohol-based cleaners may be applied.
- Clean the device in dry weather in order to make waste water evaporate quickly.

### Future Tag Replacement, Programming Changes

---

For necessary steps refer to the preceding subsections. Keep the following for future changes:

- This manual
- Unused transparent foil strips for button tags

 **Caution**

- Always use the product for the purpose it was designed and manufactured for, in compliance herewith.
- The manufacturer reserves the right to modify the product in order to improve its qualities.
- **2N<sup>®</sup> Helios Force/Safety** contains no environmentally harmful components. When the product's service life is exhausted and you would like to dispose of it please do so in accordance with applicable legal regulations



---

# 5. Technical Parameters

---

In this section we describe the technical parameters of the **2N<sup>®</sup> Helios Force/Safety** product.

## Telephone Parameters

---

Parameters	Value	Conditions
Minimum required off-hook line current	15 mA	Off-hook
Minimum required on-hook line voltage	20 V	Hang-up
DC voltage drop (off-hook)	< 8 V < 16 V	I = 25 mA I = 50 mA
Lead current while hang-up	< 25 $\mu$ A	U = 60 V
Off-hook AC impedance	220 $\Omega$ + 820 $\Omega$ 115 nF parallel	20 to 60 mA
Return loss	> 10 dB	20 to 60 mA
Bandwidth	300 to 3500 Hz	20 to 60 mA
Ring impedance	> 2 k $\Omega$ C = 1 $\mu$ F	25 to 50 Hz
Ring detector sensitivity	10 to 20 V	25 to 50 Hz
Time of response to ringing	Variable	
Pulse dialling	40/60 ms	20 to 60 mA
DTMF level	-6 and -8 dB $\pm$ 2 dB	20 to 60 mA
DTMF detector sensitivity	Min. -40 dB	20 to 60 mA
Dial tone detector sensitivity	Min. -40 dB	350 to 500 Hz
Busy tone detection speed	Variable	350 to 500 Hz
Continuous tone detection speed	Variable	350 to 500 Hz
Ring tone detection speed	Variable	350 to 500 Hz
Overvoltage protection – common mode	1000 V	8/20 $\mu$ s
Overvoltage protection – between A, B conductors	1000 V	8/20 $\mu$ s

## Other Electric Parameters

- **Switch – max. voltage:** 48 V AC, DC
- **Switch – min. voltage:** 9 V AC, DC
- **Switch – max. current:** 2 A AC, DC
- **Backlight – rated voltage:** 12 V
- **Backlight – max. voltage:** 14 V
- **Backlight – current consumption:** Up to 5 mA

## Buttons

---

- **Button design:**
  - **2N® Helios Force:** 1 to 4 transparent, white backlit buttons with easily replaceable name tags
  - **2N® Helios Safety:** One illuminated, stainless steel pushbutton

## Audio

---

- **Microphone:** 1 integrated microphone
- **Amplifier:** Optional – additional 0,5 W amplifier

## Physical Properties

---

- **Cover:** Robust aluminium cast product
- **Working temperature:** –25°C to +55°C
- **Working relative humidity:** 10% to 95% (non-condensing)
- **Storing temperature:** –40°C to 70°C
- **Dimensions:**
  - (217 × 109 × 83) mm
  - (242 × 136 × 83) mm incl. frame
- **Weight**
  - **Netto max:** 2 kg
  - **Brutto max:** 2,5 kg
- **Protection level:** IP65

---

# 6. Supplementary Information

---

This section provides supplementary information on the **2N<sup>®</sup> Helios Force/Safety** product.

Here is what you can find in this section:

- [6.1 Troubleshooting](#)
- [6.2 Directives, Laws and Regulations](#)
- [6.3 General Instructions and Cautions](#)



## 6.1 Troubleshooting



For the most frequently asked questions refer to [faq.2n.cz](http://faq.2n.cz).

## 6.2 Directives, Laws and Regulations

### Europe

---

**2N® Helios Force/Safety** conforms to the following directives and regulations:

Directive 1999/5/EC of the European Parliament and of the Council, of 9 March 1999 – on radio equipment and telecommunications terminal equipment and the mutual recognition of their conformity

Directive 2006/95/EC of the European Parliament and of the Council of 12 December 2006 on the harmonisation of the laws of Member States relating to electrical equipment designed for use within certain voltage limits

Directive 2004/108/EC of the Council of 15 December 2004 on the harmonisation of the laws of Member States relating to electromagnetic compatibility

Commission Regulation (EC) No. 1275/2008, of 17 December 2008, implementing Directive 2005/32/EC of the European Parliament and of the Council with regard to ecodesign requirements for standby and off mode electric power consumption of electrical and electronic household and office equipment

Directive 2011/65/EU of the European Parliament and of the Council of 8 June 2011 on the restriction of the use of certain hazardous substances in electrical and electronic equipment

Regulation (EC) No. 1907/2006 of the European Parliament and of the Council of 18 December 2006 concerning the Registration, Evaluation, Authorisation and Restriction of Chemicals (REACH), establishing a European Chemicals Agency, amending Directive 1999/45/EC and repealing Council Regulation (EEC) No. 793/93 and Commission Regulation (EC) No. 1488/94 as well as Council Directive 76/769/EEC and Commission Directives 91/155/EEC, 93/67/EEC, 93/105/EC and 2000/21/EC

Directive 2002/96/EC of the European Parliament and of the Council of 27 January 2003 on waste electrical and electronic equipment.

## 6.3 General Instructions and Cautions

Please read this User Manual carefully before using the product. Follow all instructions and recommendations included herein.

Any use of the product that is in contradiction with the instructions provided herein may result in malfunction, damage or destruction of the product.

The manufacturer shall not be liable and responsible for any damage incurred as a result of a use of the product other than that included herein, namely undue application and disobedience of the recommendations and warnings in contradiction herewith.

Any use or connection of the product other than those included herein shall be considered undue and the manufacturer shall not be liable for any consequences arisen as a result of such misconduct.

Moreover, the manufacturer shall not be liable for any damage or destruction of the product incurred as a result of misplacement, incompetent installation and/or undue operation and use of the product in contradiction herewith.

The manufacturer assumes no responsibility for any malfunction, damage or destruction of the product caused by incompetent replacement of parts or due to the use of reproduction parts or components.

The manufacturer shall not be liable and responsible for any loss or damage incurred as a result of a natural disaster or any other unfavourable natural condition.

The manufacturer shall not be held liable for any damage of the product arising during the shipping thereof.

The manufacturer shall not make any warrant with regard to data loss or damage.

The manufacturer shall not be liable and responsible for any direct or indirect damage incurred as a result of a use of the product in contradiction herewith or a failure of the product due to a use in contradiction herewith.

All applicable legal regulations concerning the product installation and use as well as provisions of technical standards on electric installations have to be obeyed. The manufacturer shall not be liable and responsible for damage or destruction of the product or damage incurred by the consumer in case the product is used and handled contrary to the said regulations and provisions.

The consumer shall, at its own expense, obtain software protection of the product. The manufacturer shall not be held liable and responsible for any damage incurred as a result of the use of deficient or substandard security software.

The consumer shall, without delay, change the access password for the product after installation. The manufacturer shall not be held liable or responsible for any damage incurred by the consumer in connection with the use of the original password.

The manufacturer also assumes no responsibility for additional costs incurred by the consumer as a result of making calls using a line with an increased tariff.

## Electric Waste and Used Battery Pack Handling

---



Do not place used electric devices and battery packs into municipal waste containers. An undue disposal thereof might impair the environment!

Deliver your expired electric appliances and battery packs removed from them to dedicated dumpsites or containers or give them back to the dealer or manufacturer for environmental-friendly disposal. The dealer or manufacturer shall take the product back free of charge and without requiring another purchase. Make sure that the devices to be disposed of are complete.

Do not throw battery packs into fire. Battery packs may not be taken into parts or short-circuited either.

**2N TELEKOMUNIKACE a.s.**

Modřanská 621, 143 01 Prague 4, Czech Republic

Phone: +420 261 301 500, Fax: +420 261 301 599

E-mail: [sales@2n.cz](mailto:sales@2n.cz)

Web: [www.2n.cz](http://www.2n.cz)

XXX